

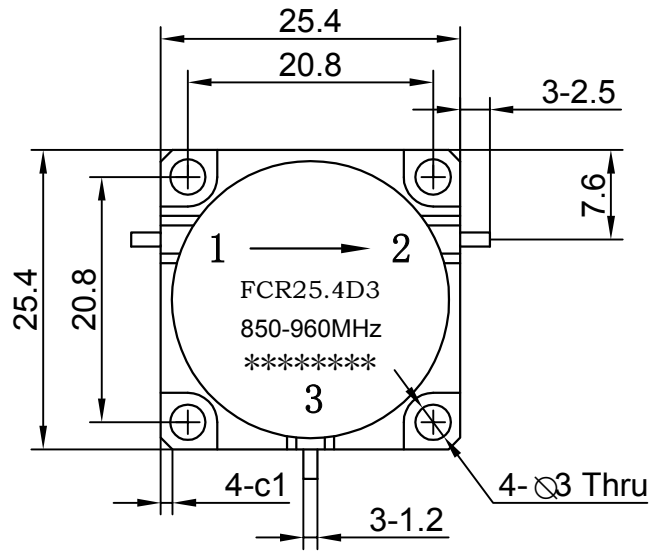

Drop-in Circulator

FCR25.4D3 850-960MHz



- Note:
- 1.Tolerances: $\pm 0.20\text{mm}$
 - 2.Material
BODY: Steel
TAB: BeCu
 - 3.Surface Treatment
BODY: Nickel plate
TAB: Silver Plated

Item	Unit	Specification	Note
Freq.Range	MHz	850-960	
Direction		CW/Right	
Operating Temperature	°C	-40~+85	
Insertion Loss	dB max	0.30	Room Temp (+25°C ± 10°C)
	dB max	0.30	Over Temp (-40°C ~ +85°C)
Isolation	dB min	23	Room Temp (+25°C ± 10)
	dB min	23	Over Temp (-40°C ~ +85°C)
Return Loss	dB min	23	Room Temp (+25°C ± 10)
	dB min	23	Over Temp (-40°C ~ +85°C)
Avg Power	W	100	
Impedance	Ω	50	

Customer suggestion and confirmation:

Signature:

Date:

Design: Colin

Format Scale Version

A4 1:1 A

Date: 2016.7.11

Page 1, Total 1



Unit: mm

www.winnsky.com