

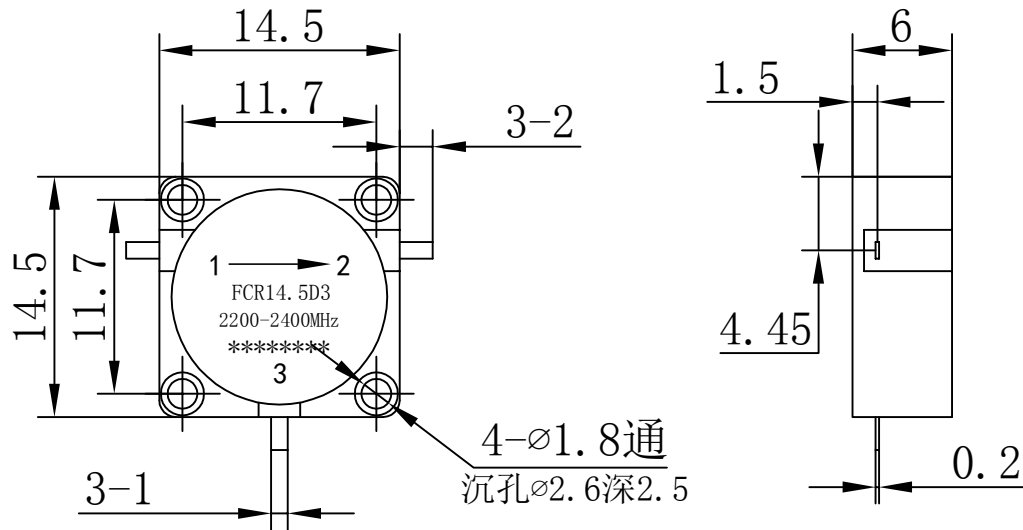

Drop-in Circulator

FCR14.5D3 2200-2400MHz



Note:

- 1.Tolerances: $\pm 0.20\text{mm}$
- 2.Material
BODY: Steel
TAB: BeCu
- 3.Surface Treatment
BODY: Nickel plate
TAB: Silver Plated

Item	Unit	Specification	Note
Freq.Range	MHz	2200-2400	
Direction		CW/Right	
Operating Temperature	°C	-40~+85	
Insertion Loss	dB max	0.40	Room Temp (+25°C ± 10°C)
	dB max	0.50	Over Temp (-40°C ~ +85°C)
Isolation	dB min	18	Room Temp (+25°C ± 10)
	dB min	16	Over Temp (-40°C ~ +85°C)
VSWR	MAX	1.30	Room Temp (+25°C ± 10)
	MAX	1.40	Over Temp (-40°C ~ +85°C)
Avg Power	W	10	
Impedance	Ω	50	

Customer suggestion and confirmation:

Signature:

Date:

Design: Colin

Format Scale Version

A4 1:1 A

Date: 2020.2.28

Page 1, Total 1



Unit: mm

www.winnsky.com