

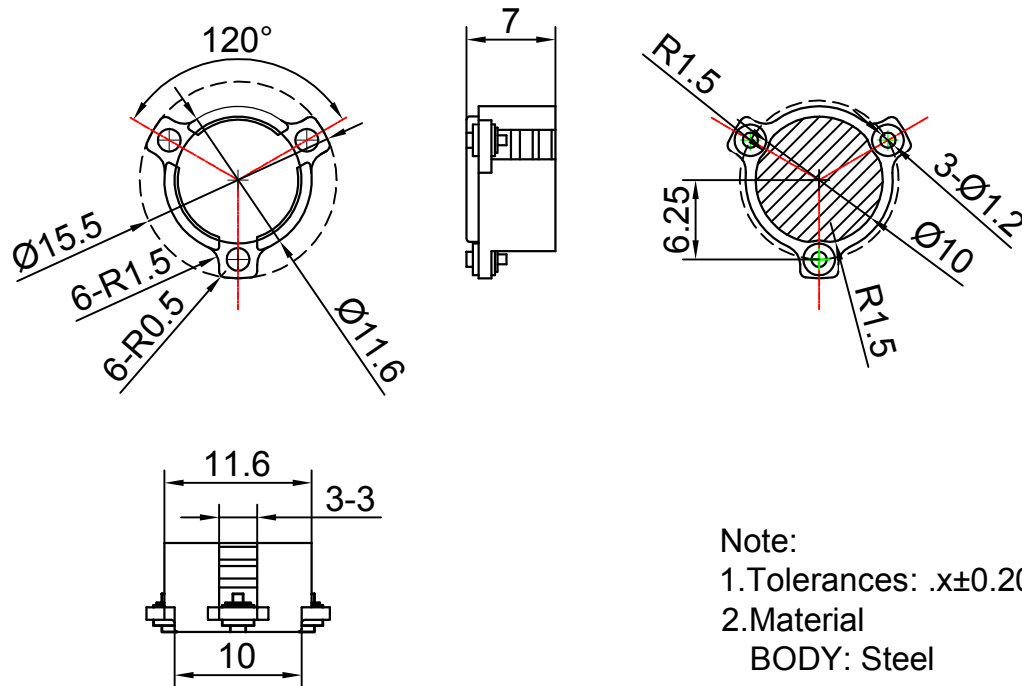

SMD Circulator

FCR10S 1880-1920MHz



Note:
 1.Tolerances: .x±0.20mm
 2.Material
 BODY: Steel
 TAB: BeCu
 PIN: Copper
 3.Surface Treatment
 BODY: Silver Plated
 TAB: Silver Plated
 PIN: Gold Plated

Item	Unit	Specification	Note
Freq.Range	MHz	1880-1920	
Direction		CW/Right	
Operating Temperature	°C	-40~+85	
Insertion Loss	dB max	0.35	Room Temp (+25°C±10°C)
	dB max	0.35	Over Temp (-40°C~+85°C)
Isolation	dB min	20	Room Temp (+25°C±10)
	dB min	20	Over Temp (-40°C~+85°C)
Return Loss	dB min	20	Room Temp (+25°C±10)
	dB min	20	Over Temp (-40°C~+85°C)
Avg Power	W	30	
Impedance	Ω	50	

Customer suggestion and confirmation:

Signature:

Date:

Design: Colin

Format Scale Version

A4 1:1 A

Date: 2016.7.11

Page 1, Total 1



Unit: mm

www.winnsky.com