

The **NDF9135** is a low-loss, compact, and economical surface-acoustic-wave (SAW) RF filter in a surface-mount ceramic **QCC8D** case for digital set top box.

1. Package Dimension (QCC8D)

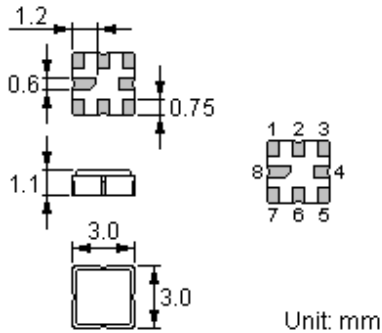

| Pin | Configuration |
|------|----------------|
| 1, 2 | Input |
| 5, 6 | Output |
| 3, 7 | to be grounded |
| 4, 8 | Case Ground |

2. Marking

**WB
1220**

Laser Marking

3. Matching Circuit

No matching network required
for operation at 200Ω

4. Typical Frequency Response

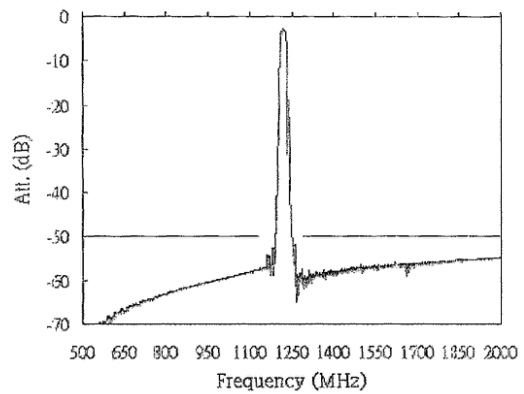
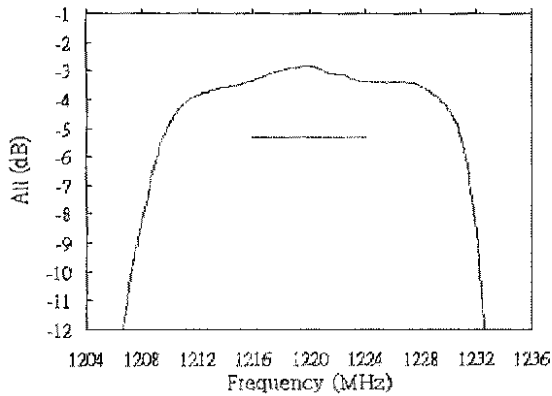
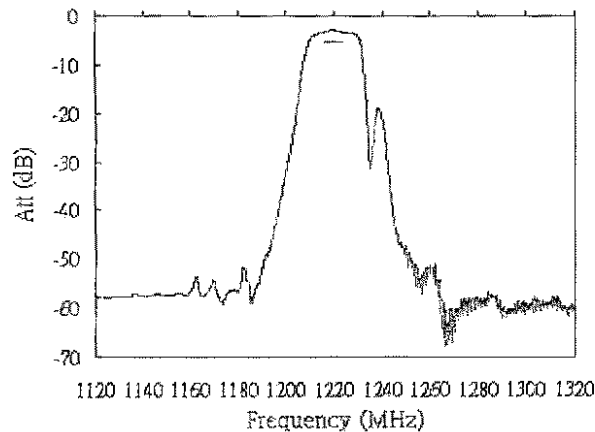

5. Performance

5-1. Maximum ratings

| Rating | | Value | Unit |
|----------------------------|-----------|------------|------|
| Maximum Input Power | P | 10 | dBm |
| DC Permissive Voltage | V_{DC} | 0 | V |
| Storage Temperature Range | T_{stg} | -40 to +85 | °C |
| Operable Temperature Range | T_A | -30 to +85 | °C |

5-2. Electronic characteristics

| Characteristic | | Min. | Typ. | Max. | Unit |
|-----------------------------------------|----------------|------|--------|------|----------|
| Center frequency | f_c | | 1220.0 | | MHz |
| Insertion Loss (± 4 MHz) | IL | | | 5.3 | dB |
| Ripple in passband (± 4 MHz) | $\Delta\alpha$ | | | 1.8 | dB |
| Stop-band attenuation | α | | | | dB |
| 500.00 1129.0 MHz | | 50.0 | | | dB |
| 1129.0 1135.0 MHz | | 50.0 | | | dB |
| 1144.0 1152.0 MHz | | 46.0 | | | dB |
| 1132.0 MHz | | 50.0 | | | dB |
| 1148.0 MHz | | 48.0 | | | dB |
| 1176.0 MHz | | 50.0 | | | dB |
| 1184.0 MHz | | 46.0 | | | dB |
| 1290.0 2000.0 MHz | | 50.0 | | | dB |
| Group delay ripple (p-p) (± 4 MHz) | $\Delta\tau$ | | 12 | | ns |
| Terminating source / load impedance | | | 200 | | Ω |

6. Packing Information

Carrier Tape

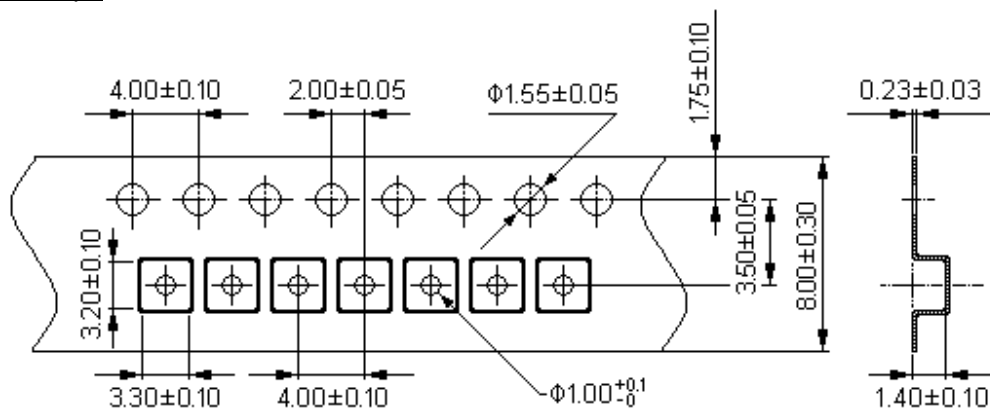

Dimensions in mm

Reel Dimensions

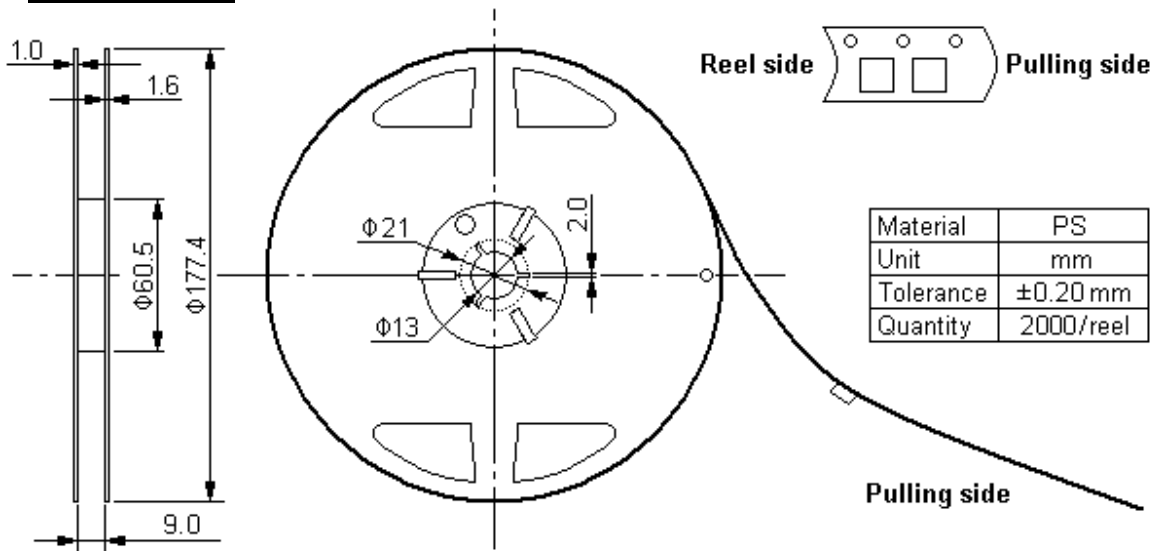

Outer Packing

| Type | Quantity | Dimension | Description | Weight |
|---------------|----------|-------------|-------------------------------------------------------|--------|
| Carton Box I | 10000 | 190×190×95 | anti-static plastic bag & carton box 1 reel / bag | 0.85 |
| Carton Box II | 20000 | 190×190×190 | 5 bags / box (10000 pcs) 10 bags / box (20000 pcs) | 1.70 |

Unit: mm

Unit: kg

7. Recommended Soldering Profile

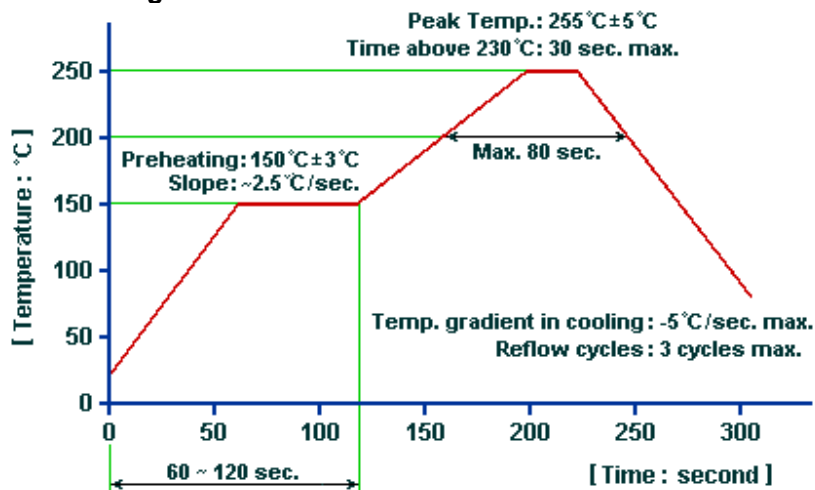

© All Rights Reserved.