

**Features**

- Low-loss RF filter for mobile systems
- Low amplitude ripple
- No matching network required for operation at 50Ω
- Ceramic package for **Surface Mounted Technology (SMT)**
- Lead-free production and **RoHS** compliant

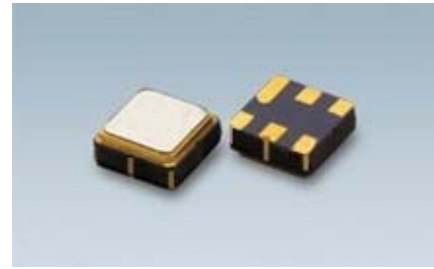

**Package Dimensions**

Ceramic Package: **DCC6C**



**Pin Configuration**

2	Input
5	Output
1, 3, 4, 6	Ground

**Marking**

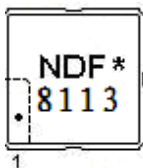

Top View, Laser Marking

- "ND": Manufacturer's mark
- "F": SAW filter
- "8113": Part number
- ".": Terminal 1
- "\*": Lot number (The code shown below varies in a 4-year cycle)

Code	1	2	3	4	5	6	7	8	9	10	11	12
2009	A	B	C	D	E	F	G	H	J	K	L	M
2010	N	P	Q	R	S	T	U	V	W	X	Y	Z
2011	a	b	c	d	e	f	g	h	i	j	k	m
2012	n	p	q	r	s	t	u	v	w	x	y	z

**Maximum Ratings**

Rating		Value	Unit
Input Power Level	$P$	23 dBm CW, $T_a=85^{\circ}\text{C}$ , life time>10 years 电气性能满足规格要求	
DC Voltage	$V_{DC}$	6	V
Operating Temperature Range	$T_A$	-40 ~ +85	$^{\circ}\text{C}$
Storage Temperature Range	$T_{stg}$	-40 ~ +85	$^{\circ}\text{C}$
ESD-HBM for all pin	$E_{SD}$	150	V

Electrical Characteristics

Item		Minimum	Typical	Maximum	Unit	
Center Frequency	$f_c$		836.5		MHz	
Insertion Loss	$IL$	--	3.2	4.0	dB	
						825.00 .... 849.00 MHz
Group Delay Ripple	825.00 .... 849.00 MHz		12	30	ns	
Absolute Attenuation	$\alpha$				dB	
						DC .... 804.00 MHz
						869.00 .... 894.00 MHz
						894.00 .... 920.00 MHz
						920.00 .... 1210.00MHz
						1210.00 .... 1500.00 MHz
						1500.00 .... 2000.00 MHz
						2000.00 .... 2600.00 MHz
2600.00 .... 3000.00 MHz						
Amplitude Ripple (p-p)	825.00 .... 849.00 MHz	$\Delta\alpha$	1.1	1.5	dB	
Input VSWR	825.00 .... 849.00 MHz		1.9: 1	2.0: 1		
Output VSWR	825.00 .... 849.00 MHz		1.9: 1	2.0: 1		
Input / Output Impedance (Nominal)			50		$\Omega$	

RoHS Compliant

Electrostatic Sensitive Device

Typical Frequency Response

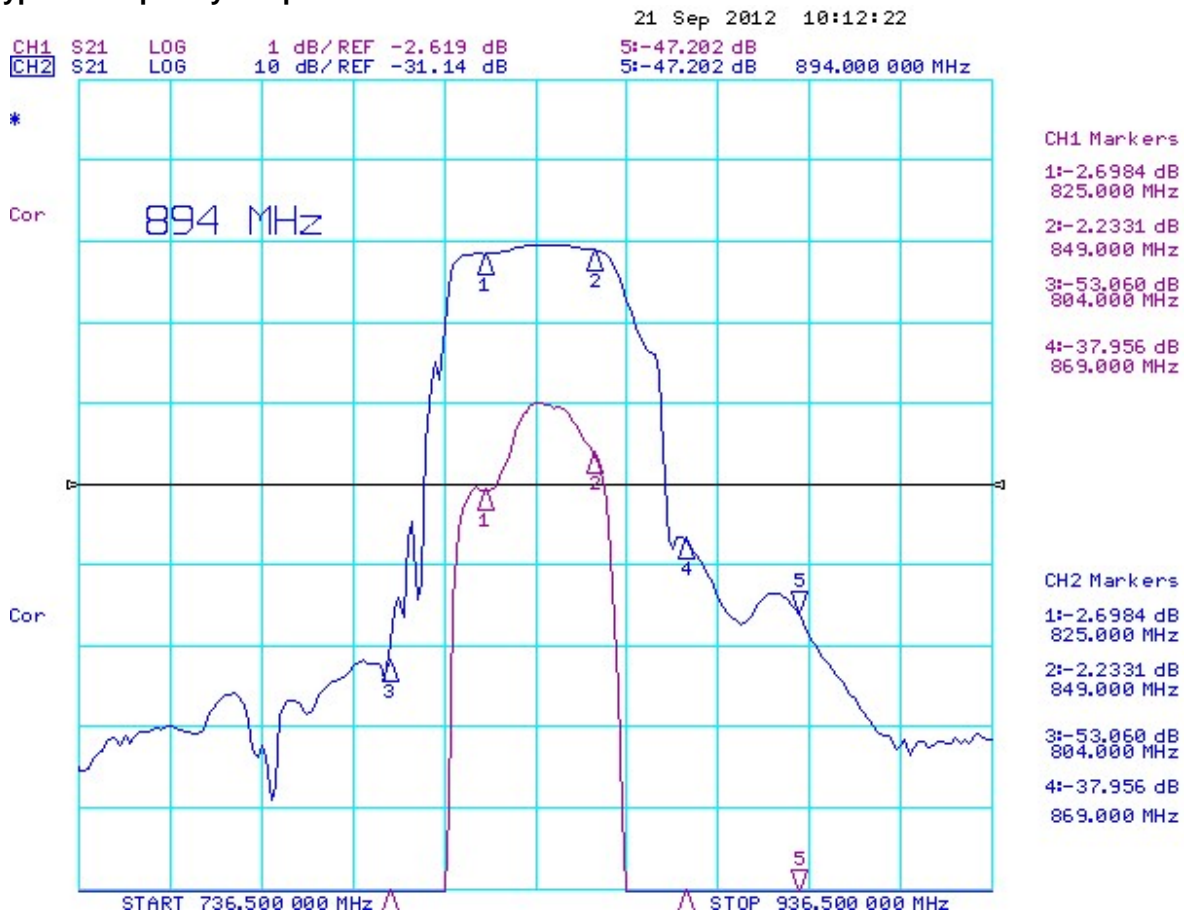

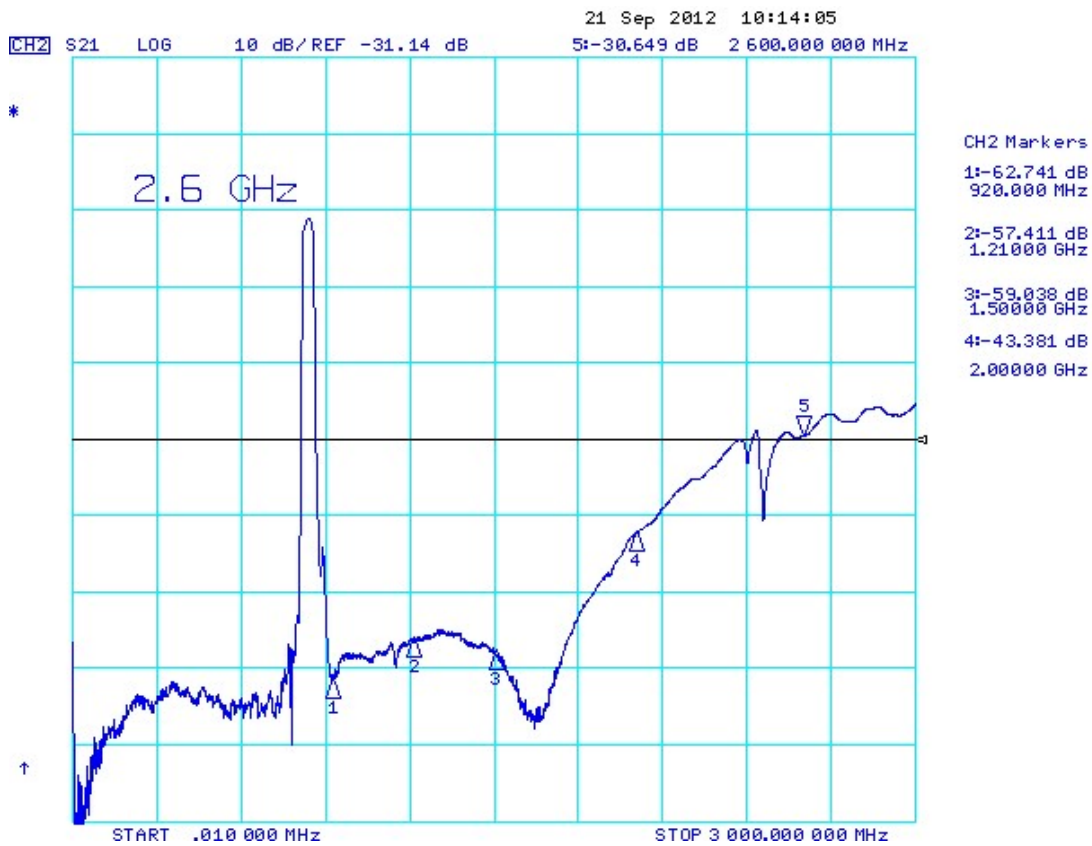
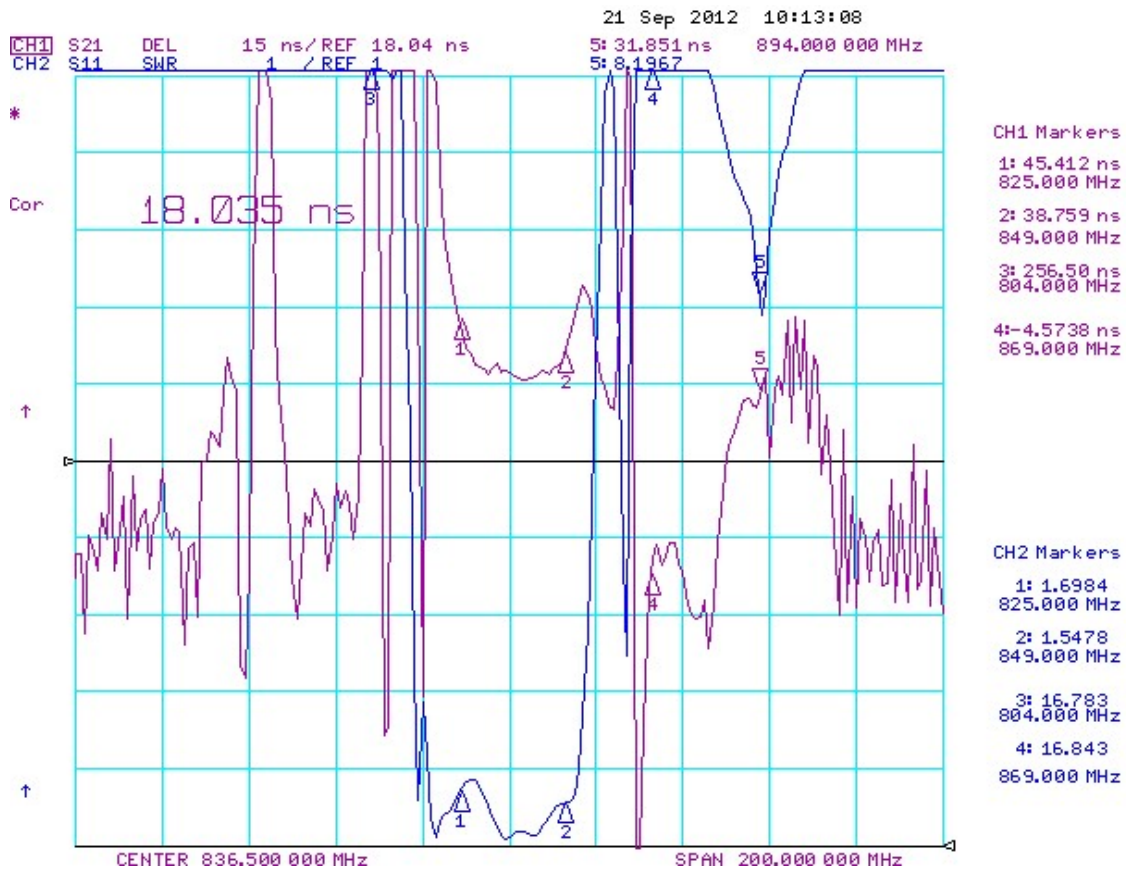

**Stability Characteristics**

	Test item	Condition of test
1	Mechanical shock	(a) Drops: 3 times on concrete floor (b) Height: 1.0 m
2	Vibration resistance	(a) Frequency of vibration: 10~55Hz (c) Directions: X,Y and Z (b) Amplitude: 1.5 mm (d) Duration: 2 hours
3	Moisture resistance	(a) Condition: 40°C ± 2°C , 93 <sup>+2</sup> <sub>-3</sub> % RH. (b) Duration: 96 hours (c) Wait 4 hours before measurement
4	Climatic sequence	(a) +70°C for 16 hours (c) -25°C for 2 hours (e) Wait 4 hours before measurement (b) +55°C for 24 hours, 90~95% R.H. (d) +40°C for 24 hours, 90~95% R.H.
5	High temperature exposure	(a) Temperature: 85°C (c) Wait 4 hours before measurement (b) Duration: 250 hours
6	Temperature cycling	(a) +85°C for 30 minutes ⇒ -40°C for 30 minutes repeated 120 times (b) Wait 4 hours before measurement

**Requirements:** The SAW filter shall remain within the electrical specifications after tests.

**Remarks**

- SAW devices should not be used in any type of fluid such as water, oil, organic solvent, etc.
- Be certain not to apply voltage exceeding the rated voltage of components.
- Do not operate outside the recommended operating temperature range of components.
- Sudden change of temperature shall be avoided, deterioration of the characteristics can occur.
- Be careful of soldering temperature and duration of components when soldering.
- Do not place soldering iron on the body of components.
- Be careful not to subject the terminals or leads of components to excessive force.
- SAW devices are electrostatic sensitive. Please avoid static voltage during operation and storage.
- Ultrasonic cleaning shall be avoided. Ultrasonic vibration may cause destruction of components.

**Test Circuit**

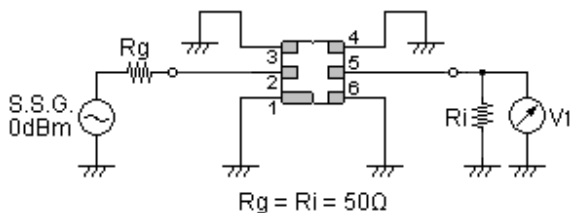

**Recommended Land Pattern**

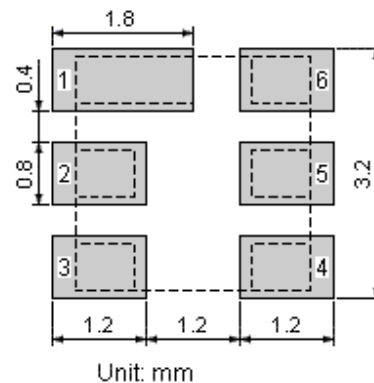

**Packing Information**

Carrier Tape

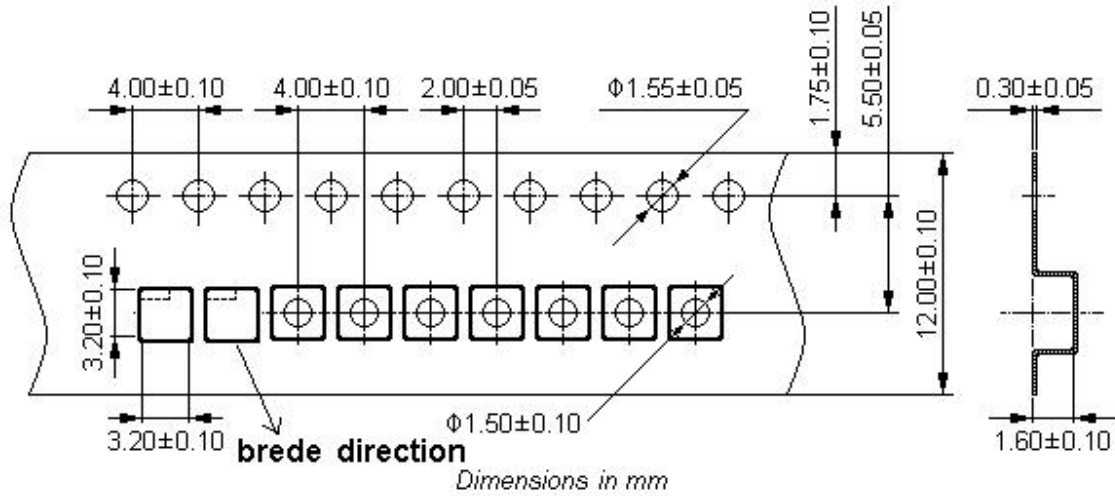

Reel Dimensions

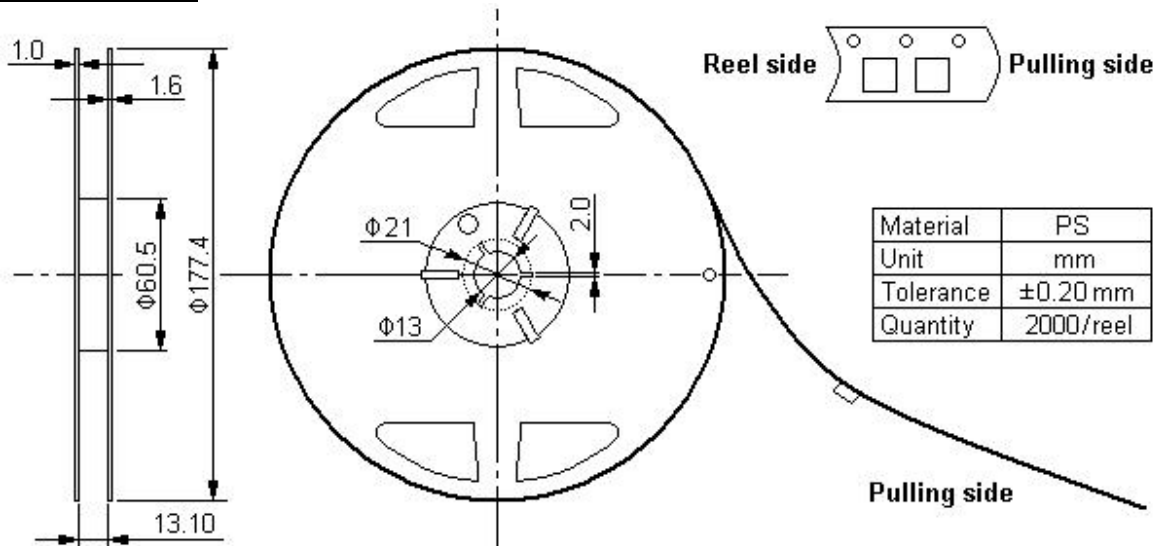

Outer Packing

Type	Quantity	Dimension	Description	Weight
Carton Box I	10000	190×190×95	anti-static plastic bag & carton box 1 reel / bag	0.85
Carton Box II	20000	190×190×190	5 bags / box (10000 pcs) 10 bags / box (20000 pcs)	1.80

Unit: mm

Unit: kg

Recommended Soldering Profile

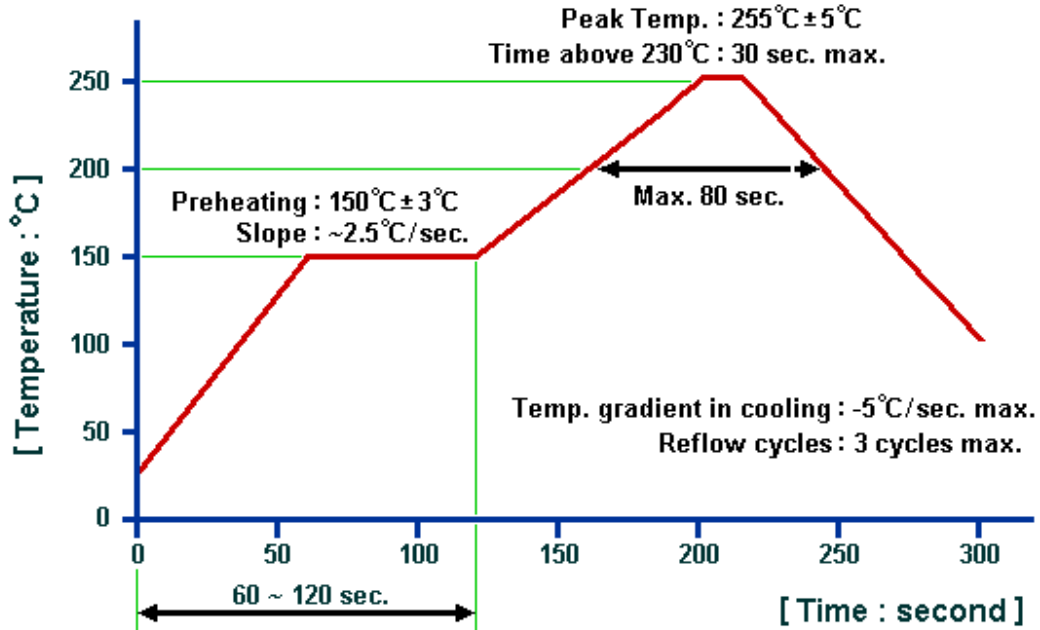

© NEDI 2012. All Rights Reserved.

1. The specifications of this device are subject to change or obsolescence without notice.
2. Typically, equipment utilizing this device requires emissions testing and government approval, which is the responsibility of the equipment manufacturer.
3. Our liability is only assumed for the Surface Acoustic Wave (SAW) component(s) per se, not for applications, processes and circuits implemented within components or assemblies.
4. For questions on technology, prices and delivery, please contact our sales offices or e-mail [winnsky@winnsky.com](mailto:winnsky@winnsky.com)